



Totally Focused. Totally Independent.

Technical Guide

ECP32 4 C

G-TYPE



The world's largest
independent producer of
alternators 1 – 5,000kVA

Standards

Alternators are designed and produced within an ISO 9001 environment. The entire series is manufactured according to, and complies with, the most common specifications such as CEI 2-3, IEC 34-1, EN 60034-1, VDE 0530, BS 4999-5000, NF 51.111, NEMA MG 1-2011, ISO 8528-3. They also comply with other specific standards such as UL1446, UL 1004/4 and /B and CAN/CSA-C22.2 No14-95-No100-95.

Windings and Performances

All windings are 2/3rds pitch to eliminate triplen harmonics within the voltage waveform and to avoid excessive neutral currents in certain parallel operating conditions. A fully interconnected aluminium or copper damper cage is supplied on the rotor of all models (excluding the ECP3 series).

- ▶ 12 wire reconnectable:
 - 50Hz – 380V to 440V and 220/110V to 240/120V (de-rates may apply at certain voltages)
 - 60Hz – 380V to 480V and 220/110V to 240/120V (de-rates may apply at certain voltages)
- ▶ 6 wire reconnectable:
 - 50Hz – 380V to 440V and 220V to 240V (de-rates may apply at certain voltages)
 - 60Hz – 380V to 480V and 220V to 240V (de-rates may apply at certain voltages)

Winding Configurations	Standard		Special (dedicated)			
	12 wire Reconnectable	6 wire Reconnectable	380V and 600V 60Hz	690V 50/60Hz	220-240V 1ph 50Hz	220-240V 1ph 60Hz
ECP3 to ECO38	Std	Option	Option	Option	Option	Option
ECO40	Std	Option	Option	Option	Option (to ECO40)	Option (to ECO40)
Insulation materials	Class H	Class H	Class H	Class H	Class H	Class H
High efficiency	Std	Std	Std	Std	Std	Std
High motor starting	>300%	>300%	>300%	>300%	>300%	>300%
THD (Total Harmonic Distortion)	Typically <3.5% full load L-L	Typically <3.0% full load L-L	Typically <3.5% full load L-L	Typically <3.5% full load L-L	Typically <4.5% full load L-N	Typically <4.5% full load L-N
Interference suppression	VDE 0875 C/N/K, EN61000-6-3, EN61000-6-2, others available on request					

Winding Protection

There are various degrees of protection for the windings following the standard impregnation process, as can be seen here. The TOTAL+ epoxy black coating is recommended for arduous applications.

Winding Protection:	STANDARD	STANDARD+	GREY	GREY+	TOTAL+
ECP3	Std	Option	Option	Option	Option
ECP28 and ECP32	-	Std	Option	Option	Option
NPE32, ECP34 to ECO40	-	-	Std	Option	Option



Grey treatment (marinization) on the left, TOTAL+ treatment shown on the right. The EG43 grey varnish, is a high temperature insulating enamel that forms a tough and flexible film, with excellent moisture and chemical protection. It is water and oil proof, and also protects windings from abrasion. It is applied spraying an over coating layer over the impregnated winding, or dipping the stator in a varnish barrel for superior treatments

The TOTAL+ is a protection system that makes Mecc Alte special. It is the ultimate winding treatment that offers truly superior performances when the environment is really harsh, or the application very demanding. The TOTAL+ is also extremely resistant to the particle abrasion as it adsorbs the impacts.

Protection for Environment

In addition to protection on the windings themselves, the alternators can have increased degree of protection. Standard level is IP23 but the following solutions are also available: IP23 DP with inlet filters, IP23 with only terminal box in IP45, IP43 and IP45. Derates may be applied.

Info: https://www.meccalte.com/downloads/MA0605_Bulletin_IP.pdf

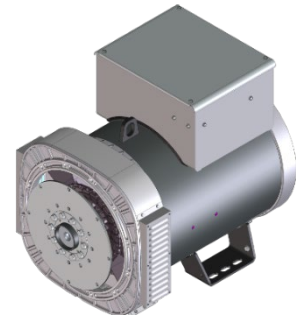

Construction

The robust mechanical structure withstands up to 5G in any direction and 9G vertically and its design permits easy access to the connections and components during routine maintenance check-ups. The mechanical design has used the most advanced FEM techniques. The materials used are: FEP12 steel for the frame, C45 steel for the shaft and cast iron or aluminum pressure die cast for the end-brackets: fans are aluminum die casted either nylon fiber glass loaded, UL compliant materials. Rotors are dynamically balanced according grades 6.3 (up to series 32) or 2.5 (from series 34 onwards) of ISO 1940-1.

Terminals and Terminal Box

Easy access to regulators is possible due to a new AVR panel. Terminal boards have been redesigned into a special L configuration, specifically to ease customer connections; with this kind of terminal board it is possible to place a second terminal board in order to get 12 available terminals. Current transformers are available as an option on series ECO38 with single or dual output.

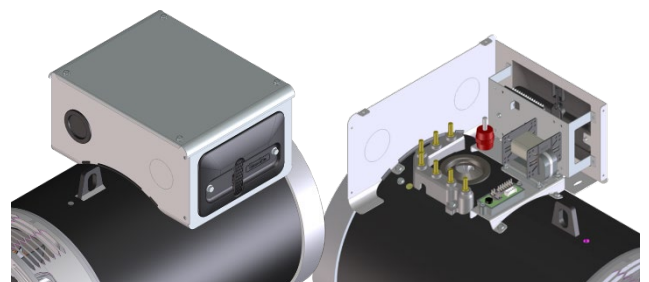

Excitation and Regulation Systems

All ECP/ECO series have MAUX auxiliary winding to power the digital regulator. Both DSR and the DER1 are available to connect to PC through the DxR2 USB interface and DxR TERMINAL software to interrogate/download alarms & settings for analysis or for cloning other regulators. DER2 has got an integrated USB connection and can be connected to the PC without any optional connection boards. More settings such as LAMS, digital RAM based synchronous external control and soft start are obtainable through the DxR connection. Simple analogue potentiometers are available for the more usual adjustments.

Excitation Systems	DSR	DER1	DER2
ECP3 to ECO38	Std	Option	Option
ECO40	-	Std	Option
Parallel Operation	√	√	√
Mains Parallel	√	√	√
3 Phase Sensing (rms)	-	√	√
Accuracy	+/-1%	+/-0.5%	+/-0.5%
Remote Voltage Control	√	√	√
Alarm Log	√	√	√
Analogue and Digital Configurable	√	√	√
LAMS (Load Acceptance V/f)	√	√	√
APO (Active Protection Output)	√	√	√
Soft Start	√	√	√
High dynamic response	-	-	√
USB connection without external boards	-	-	√

For a given motor start duty a smaller machine may be selected – also enhanced by low sub-transient reactance values for non-linear loads. The whole range is capable of >300% sustained short circuit current for up to 20 seconds.

Optional PMG

The Mecc Alte PMG is available on ECP28, ECP32, ECP34 and ECO38 as factory-fitted option; alternatively, only the predisposition for the retrofit, for subsequent assembly, is available on option. On series ECO40 is available as a factory-fitted or retro-fitted options.

The complete AVR range is fully compatible with both MAUX and PMG systems; this minimises spare parts management and flexibility of stock as one AVR suits all applications.

The PMG is delivering the same amount of kVA available with the MAUX.



Dew Heater

Our whole range can be fitted with anti-condensation heaters of adequate power sized to alternator kVA. Voltage for heaters must be specified when ordering. New cylindrical cartridge style heaters are available on request and it can be retrofitted.

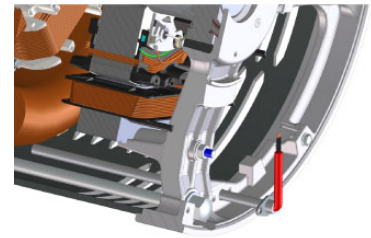

Accessories

Additional optionals can be fit on our alternator series, such as PTC thermistors or PT100 both on windings and bearings, dew heaters, high and low profile of terminal boxes (on most series), parallel devices (standard from ECO38), current and voltage transformers, air filters, IP43 and IP45 protections and many others.

For more info visit: <https://www.meccalte.com/en/products/alternators/accessories/c-type-accessories>

Deration coefficients

Altitude (meters)	Ambient temperature (Celsius)					
	25	40	45	50	55	60
≤ 1000	1.07	1	0.96	0.93	0.91	0.89
$> 1000 \leq 1500$	1.01	0.96	0.92	0.89	0.87	0.84
$> 1500 \leq 2000$	0.96	0.91	0.87	0.84	0.83	0.79
$> 2000 \leq 3000$	0.9	0.85	0.81	0.78	0.76	0.73

Notes on short circuit curves

The indicated coefficients have to be used to correct the three phase short circuit curves values as a function of the rated voltage.

The indicated coefficient have to be used to correct the three phase short circuit curves values as a function of the type of short circuit voltage.

50 Hz		60 Hz	
Voltage	Factor	Voltage	Factor
380	0.93X	415	0.85X
400	1X	440	0.90X
415	1.04X	460	0.95X
440	1.10X	480	1X

	3 phase	2 phase L-L	1 phase L-N
<i>Istantaneous</i>	1X	0.87X	1.30X
<i>Minimum</i>	1X	1.80X	3.20X
<i>Sustained</i>	1X	1.50X	2.50X
<i>Max Duration</i>	20 sec.	10 sec.	4 sec.

All the curves are shown for series or parallel star connection at 400V 50 Hz or 480V 60 Hz. If the unit is reconnected from series to parallel star, the additional coefficient is 2X. From series star to series delta, it is 1.72X. From series star to parallel delta, it is 3.44X.

General characteristics

Pole number	4	Insulation class	H
Phase number	3	Protection class	IP23
Number of wires	12	NDE Bearing type	6309-2RS
Execution	Brushless	DE Bearing type	6312-2RS
Regulator type	DSR	Maximum Overspeed	2250
Winding pitch	2/3	Altitude	≤ 1000
Code voltage reference	T0405S3	Balancing	ISO1940-1

Ratings

400V - 50Hz @ 125/40°C - 0.8 PF - Standard		ECP32 2L4 C
Rated power	kVA	82,5
	kW	66

Reactance & Time constants

Unsaturated (ref. EN60034-4)		ECP32 2L4 C
X_d	Direct-axis synchronous reactance %	376
X'_d	Direct-axis transient reactance %	16,8
X''_d	Direct-axis subtransient reactance %	8,7
X_q	Quadrature-axis synchronous reactance %	147,9
X'_q	Quadrature-axis transient reactance %	147,9
X''_q	Quadrature-axis subtransient reactance %	43,1
X₂	Negative-sequence reactance %	25,3
X₀	Zero sequence reactance %	4,11
Saturated		
X_d	Direct-axis synchronous reactance %	319,6
X'_d	Direct-axis transient reactance %	14,3
X''_d	Direct-axis subtransient reactance %	7,4
X_q	Quadrature-axis synchronous reactance %	125,7
X'_q	Quadrature-axis transient reactance %	125,7
X''_q	Quadrature-axis subtransient reactance %	36,6
X₂	Negative-sequence reactance %	21,5
X₀	Zero sequence reactance %	4,11
K_{cc}	Short circuit ratio	0,31
T'_d	Transient time constant sec	0,074
T''_d	Subtransient time constant sec	0,016
T'_{do}	Open circuit time constant sec	1,67
T_a	Armature time constant sec	0,022

Additional information

I_o	Excitation current at no load	A	0,6
I_c	Excitation current at full load	A	2,9
Overload			1 hour in a 6 hours period 110% rated load
	Overload per 20 sec.	%	300
	Heat dissipation	W	7333
	Telephone Harmonic Factor - THF	%	<2
	Waveform Distors.(THD) full load LL/LN	%	2,9 / 2,9
	Waveform Distors.(THD) no load LL/LN	%	2,5 / 2,5

Efficiencies @ 50 Hz

Models		400/230V 50Hz				
		0.25	0.5	0.75	1	1.1
ECP32 2L4 C	%	91,7	92,1	91,2	90,0	89,5

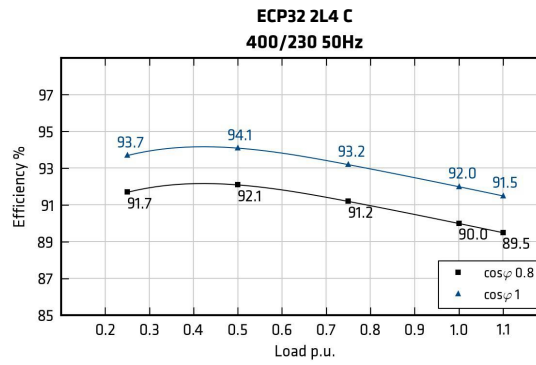

Transients voltage

400V - 50Hz

Motor Starting @ P.F. 0,6

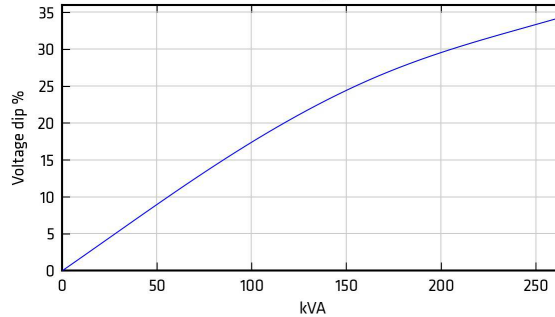

Phase Loading @ P.F. 0,8

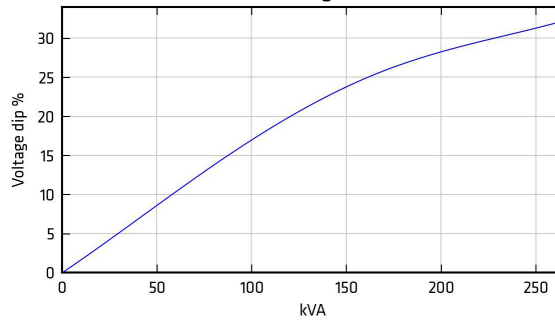

Load Shedding @ P.F. 0,8

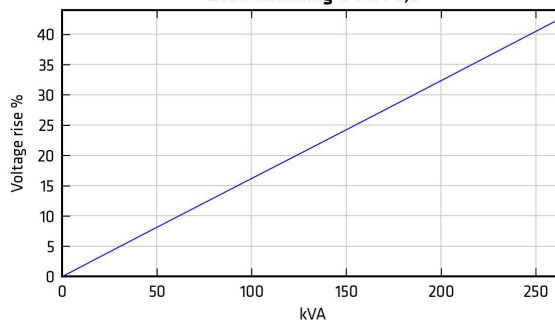

In order to scale transient curves as a function of a power factor or voltage if not indicated, please proceed as follows:

Power Factor coefficient corrector (PFCC), to be used on power factor 0.6 curves:

$$PFCC = \sin(\text{ARCCos}(PF_{\text{new}})) / 0.8$$

Example. The PFCC at power factor 0.3 is 1.192 [$PFCC = \sin(\text{ARCCos}(0.3)) / 0.8$]. This means that the voltage fall at a given power at pf 0.3 is equivalent to the one that can be read on the pf 0.6 curve if the load is considered 1.192 times bigger (19% higher value.).

In this example, a 100 kVA load insertion at pf 0.3 is equivalent in voltage fall to a 119kVA load insertion at pf 0.6.

Voltage coefficient corrector (VCC):

$$VCC = (400/V_{\text{new}})^2 \text{ if } 50 \text{ Hz}; VCC = (480/V_{\text{new}})^2 \text{ if } 60 \text{ Hz}$$

Example. VCC at 415V 60 Hz is 1.338 [$VCC = (480/415)^2$]. This means that the voltage fall at a given power at 415V is equivalent to the one that can be read on the power factor 0.6 curve if the load is considered 1.338 times bigger (33% higher value.).

In this example, a 100 kVA load insertion at 415V is equivalent in voltage fall to a 133kVA load insertion at 480V.

50Hz Short circuit decrement curves - No load excitation at rated speed

ECP32 2L4 C

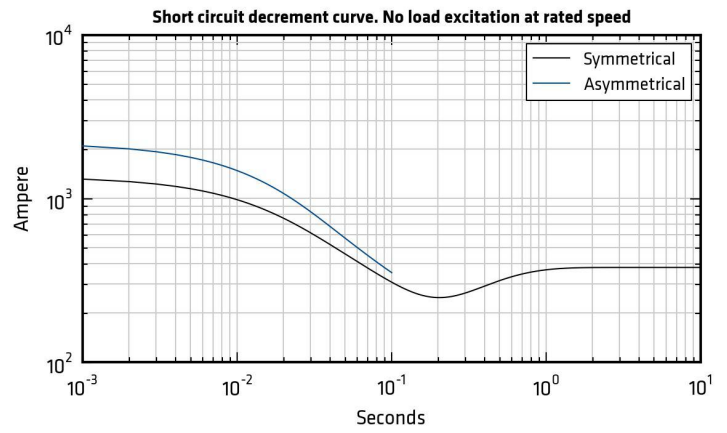

*Please refer to tables at page 6

Additional Characteristics

Data	ECP32 2L4 C	
		50 Hz
Damper cage		Aluminium
Stator Winding Resistance (20°C)	Ω	0,035
Rotor Winding Resistance (20°C)	Ω	1,715
Stator Exciter Resistance (20°C)	Ω	10,6
Rotor Exciter Resistance (20°C)	Ω	0,417
Weight of complete generator	kg	252,0
Unbalanced magnetic pull	kN/mm	5,2
Air flow	m ³ /min	15,7
Noise level at 1m/7m	dB(A)	72/58

PQ Diagram

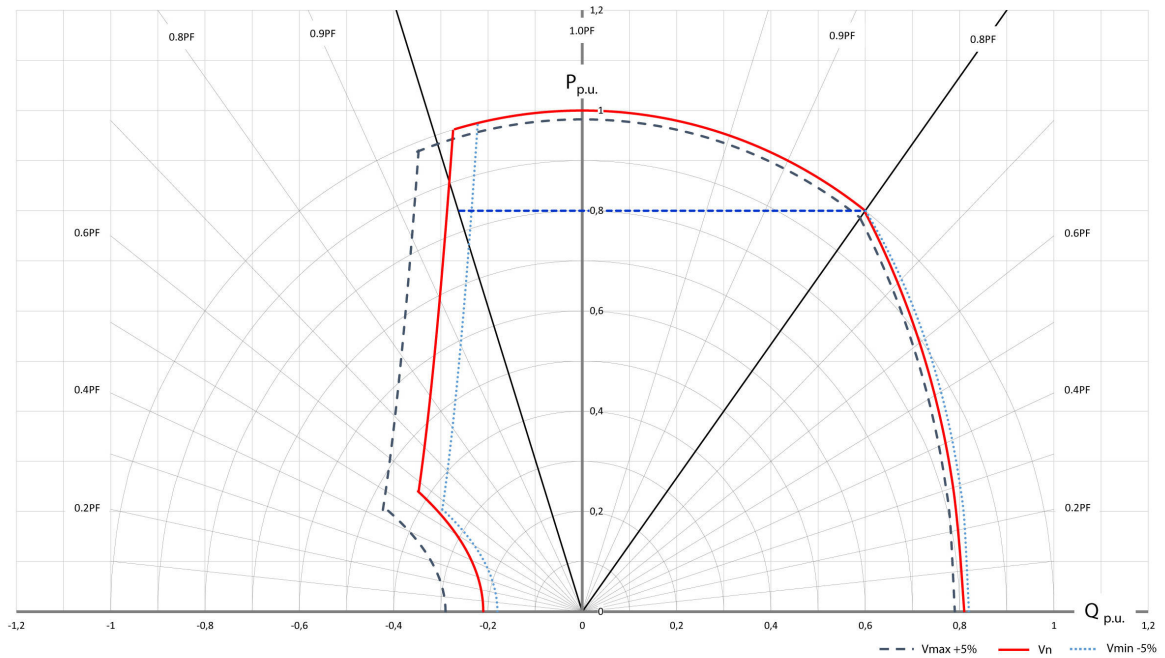

ECP32 2L4 C

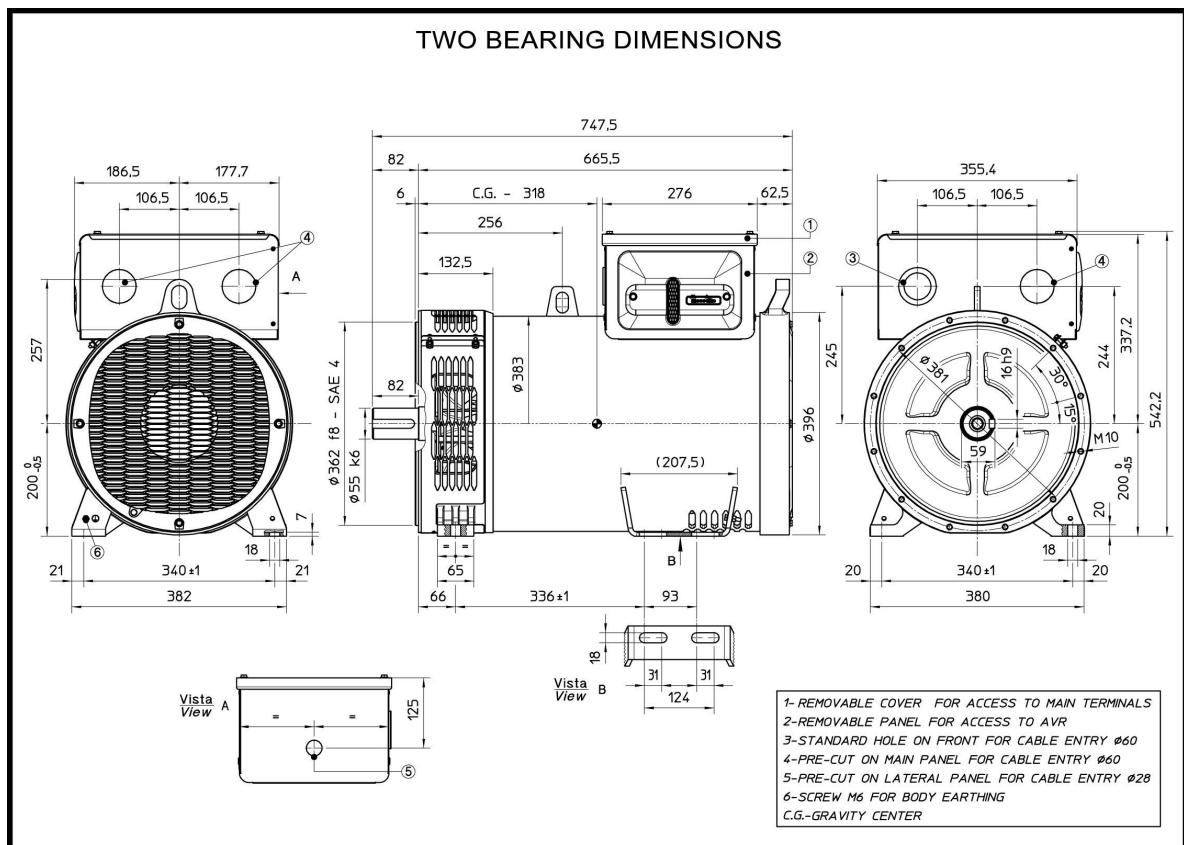
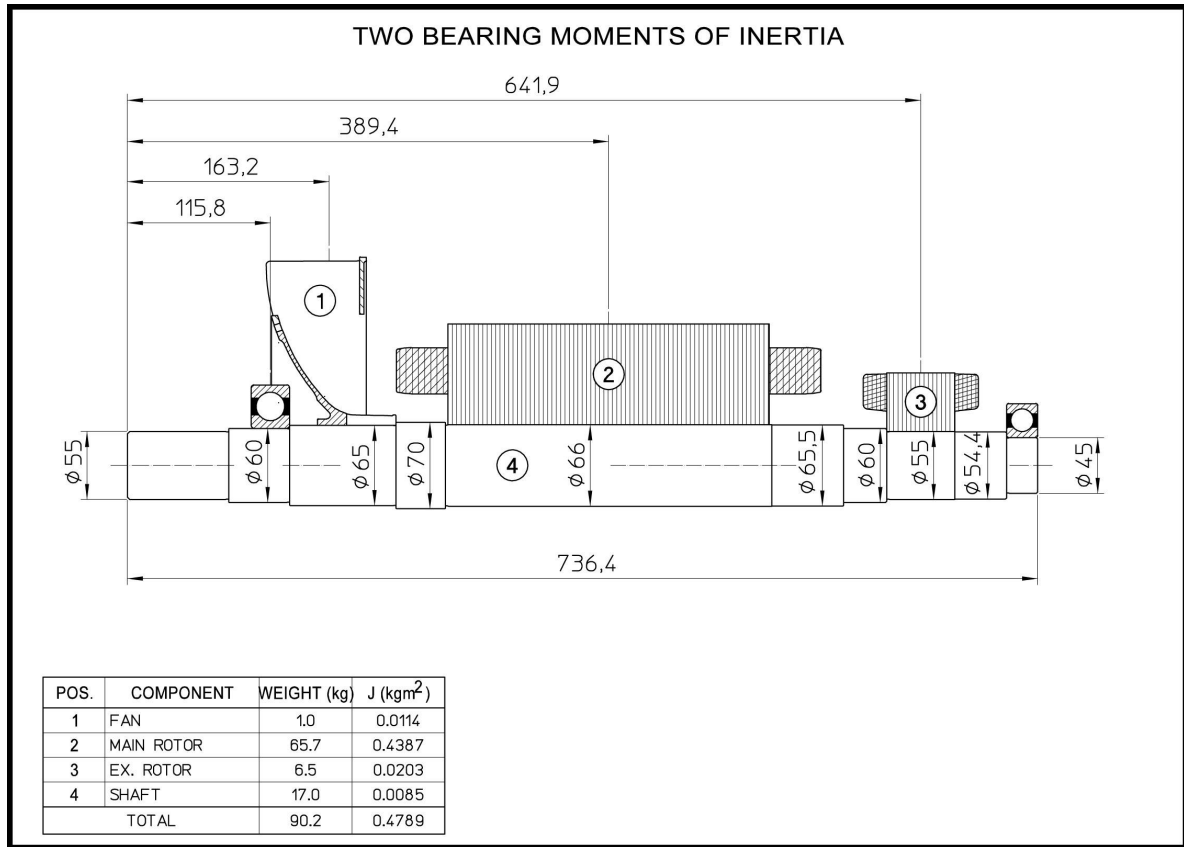

SINGLE BEARING MOMENTS OF INERTIA

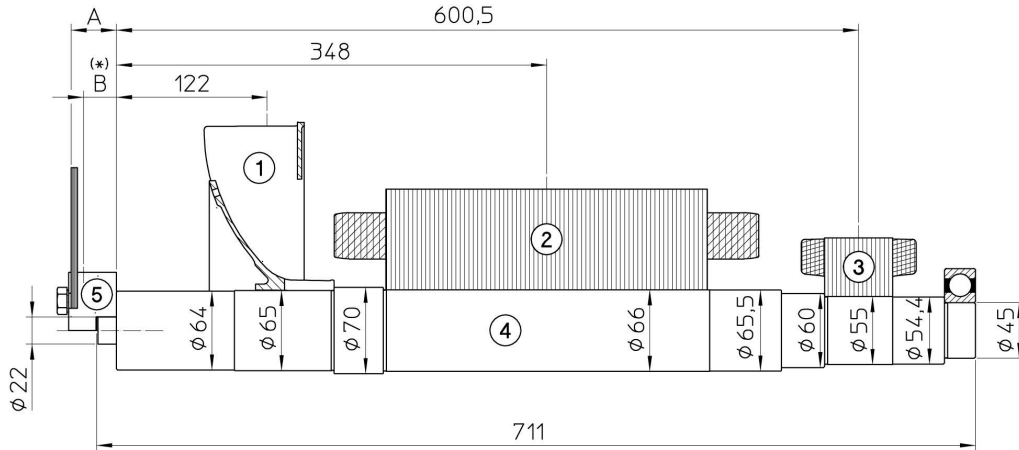

POS.	COMPONENT	WEIGHT (kg)	J (kgm ²)
1	FAN	1.0	0.0114
2	MAIN ROTOR	65.7	0.4387
3	EX. ROTOR	6.5	0.0203
4	SHAFT	16.7	0.0086
TOTAL		89.9	0.4790

SAE N°	A	B	WEIGHT kg	J kgm ²
6 1/2	5	2.2	1.7	0.0084
7 1/2	5	2.2	2.1	0.0130
8	36.6	25.9	4.0	0.0203
10	28.6	21.6	4.5	0.0385
11 1/2	15	11.5	4.5	0.0590

(*) - FLYWHEEL GRAVITY CENTER

SINGLE BEARING DIMENSIONS

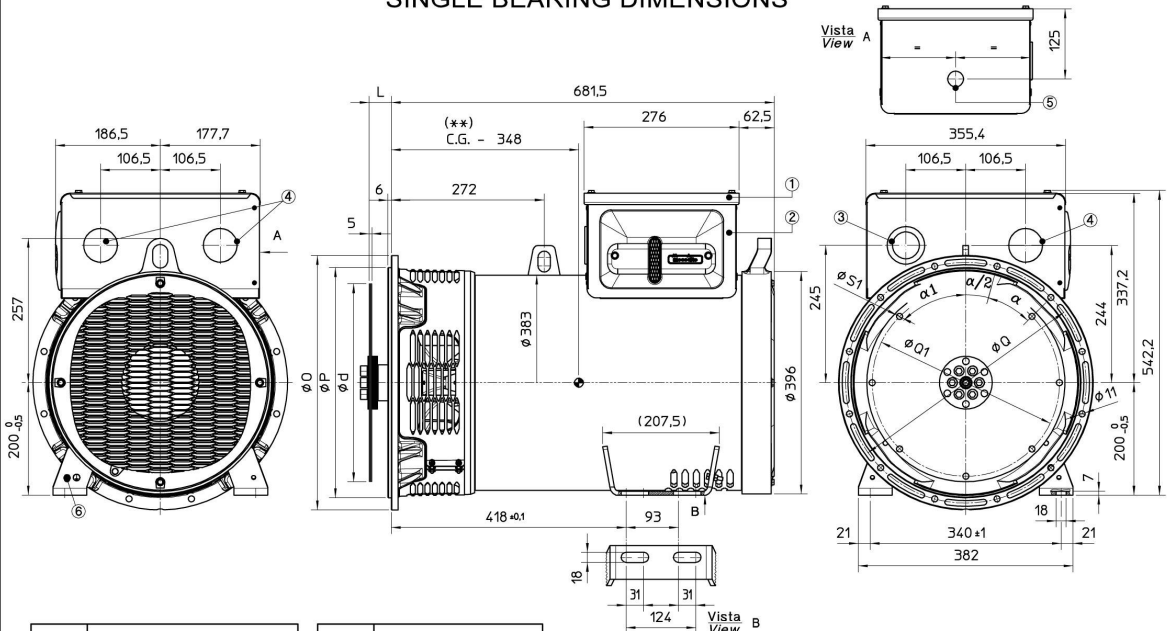

SAE N.	d	L	Q1	S1	α1
6 1/2	215.9	30.2	200	9	60°
7 1/2	241.3	30.2	222.25	9	45°
8	263.52	62	244.47	11	60°
10	314.32	53.8	295.27	11	45°
11 1/2	352.42	39.6	333.37	11	45°

SAE N.	O	P	Q	α
5	356	314.3	333.4	45°
4	402	362	381	30°
3	453	409.6	428.6	30°
2	490	447.7	466.7	30°
1	553	511.2	530.2	30°

- 1- REMOVABLE COVER FOR ACCESS TO MAIN TERMINALS
- 2- REMOVABLE PANEL FOR ACCESS TO AVR
- 3- STANDARD HOLE ON FRONT FOR CABLE ENTRY Ø60
- 4- PRE-CUT ON MAIN PANEL FOR CABLE ENTRY Ø60
- 5- PRE-CUT ON LATERAL PANEL FOR CABLE ENTRY Ø28
- 6- SCREW M6 FOR BODY EARTHING

(**) - GRAVITY CENTER IN CONFIGURATION SAE 3 FLYWHEEL 11 1/2

Mecc Alte SpA (HQ)

Via Roma
20 - 36051 Creazzo
Vicenza - ITALY
T: +39 0444 396111
F: +39 0444 396166
E: info@meccalte.it
aftersales@meccalte.it

Mecc Alte Portable

Via Roma
20 - 36051 Creazzo
Vicenza - ITALY
T: +39 0444 396111
F: +39 0444 396166
E: info@meccalte.it
aftersales@meccalte.it

Mecc Alte Power Products srl

Via Melaro
Z - 36075 Montecchio
Maggiore (VI) - ITALY
T: +39 0444 1831295
F: +39 0444 1831306
E: info@meccalte.it
aftersales@meccalte.it

Zanardi Alternatori srl

Via Dei Laghi
48/B - 36077 Altavilla
Vicenza - ITALY
T: +39 0444 370799
F: +39 0444 370330
E: info@zanardialternatori.it

United Kingdom

Mecc Alte U.K. LTD
6 Lands' End Way
Oakham
Rutland LE15 6RF
T: +44 (0) 1572 771160
F: +44 (0) 1572 771161
E: info@meccalte.co.uk
aftersales@meccalte.co.uk

Spain

Mecc Alte España S.A.
C/ Rio Taibilla, 2
Polig. Ind. Los Valeros
03178 Benijofar (Alicante)
T: +34 (0) 96 6702152
F: +34 (0) 96 6700103
E: info@meccalte.es
aftersales@meccalte.es

China

Mecc Alte Alternator Haimen LTD
755 Nanghai East Rd
Jiangsu HEDZ 226100 PRC
T: +86 (0) 513 82325758
F: +86 (0) 513 82325768
E: info@meccalte.cn
aftersales@meccalte.cn

India

Mecc Alte India PVT LTD
Plot NO: 1, Sanaswadi
Talegaon
Dhamdhare Road Taluka:
Shirur, District:
Pune - 412208
Maharashtra, India
T: +91 2137 619600
F: +91 2137 619699
E: info@meccalte.in
aftersales@meccalte.in

U.S.A. and Canada

Mecc Alte Inc.
1229 Adams Drive
McHenry, IL, 60051
T: +1 815 344 0530
F: +1 815 344 0535
E: info@meccalte.us
aftersales@meccalte.us

Germany

Mecc Alte Generatoren GmbH
Ensener Weg 21
D-51149 Köln
T: +49 (0) 2203 503810
F: +49 (0) 2203 503796
E: info@meccalte.de
aftersales@meccalte.de

Australia

Mecc Alte Alternators PTY LTD
10 Duncan Road, PO Box 1046
Dry Creek, 5094, South
Australia
T: +61 (0) 8 8349 8422
F: +61 (0) 8 8349 8455
E: info@meccalte.com.au
aftersales@meccalte.com.au

France

Mecc Alte International S.A.
Z.E.La Gagnerie
16330 ST.Amant de Boixe
T: +33 (0) 545 397562
F: +33 (0) 545 398820
E: info@meccalte.fr
aftersales@meccalte.fr

Far East

Mecc Alte (F.E.) PTE LTD
19 Kian Teck Drive
Singapore 628836
T: +65 62 657122
F: +65 62 653991
E: info@meccalte.com.sg
aftersales@meccalte.com.sg



www.meccalte.com